

CS5 Service Parts Replacement Guide

CS5 ELECTRONICS

PART	INVACARE PART NUMBER
HEAD ACTUATOR *ITEM# LA27-U041-00 *NUMBER ON MOTOR IS 1147531 *INCLUDES 3 WIRETIES	1159613 
HEAD MOTOR CABLE (YELLOW "O" RING)	1116642 
FOOT ACTUATOR *ITEM# LA27-U042-00	1147532 
FOOT MOTOR CABLE (BLUE "O" RING)	1116641 
FOOT MOTOR EXTENSION TUBE	1149695 
HILO ACTUATOR 6000N, 3mm SPIN *ITEM# LA27-U061-00	1142183 
HILO MOTOR CABLE (RED "O" RING)	1116640 
HILO MOTOR CABLE (BLACK "O" RING)	1147601 







Yes, you can:

CS5 Service Parts Replacement Guide

<p>CONTROL BOX 120V, 4 PORT FET, CB6038-XX, CS5 *XX IS THE REVISION LEVEL AND DOESN'T AFFECT ANYTHING *NUMBER ON CONTROL BOX IS 1147581 *INCLUDES 2 WIRETIES</p>	<p>1159601</p> 
<p>POWER CORD</p>	<p>1165079</p> 

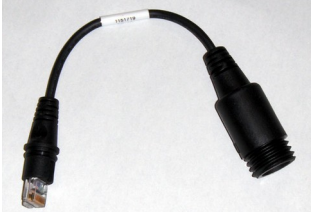
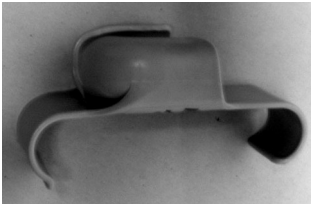
PENDANTS

<p>6 FUNCTION  RJ48 CONNECTOR</p>	<p>1158391</p> 
<p>PENDANT CROSSOVER CABLE *GETS ATTACHED AT THE END OF THE Y CABLE</p>	<p>1151719</p> 
<p>PENDANT HOLSTER</p>	<p>PNDNTHOLSTERS- New part 1186847</p> 
<p>T-CABLE 330MM NO FOOT OPTIONS</p>	<p>1147594NLA Replace with: 1158433</p> 

CS5 Service Parts Replacement Guide

STEEL AND FRAME PARTS

<p>HEAD DECK</p> <p>*PLACEMENT OF MATTRESS KEEPER DETERMINES 80" OR 76"</p>	<p>1158933 39" wide 1165156 42" wide 1165158</p> 
<p>FOOT AND KNEE DECK</p> <p>*PLACEMENT OF MATTRESS KEEPER DETERMINES 80" OR 76"</p>	<p>1149693 (comes with both foot and knee) 39" thigh and foot together 1165160 42" thigh and foot together 1165162 Also order 6: NUT516PN—Part is OBSOLETE</p> 
<p>BED FRAME</p>	<p>1149706</p> 
<p>STABILIZER LINK</p>	<p>1149704</p> 



Yes, you can.

CS5 Service Parts Replacement Guide

<p>BED LEG</p>	<p>1149705 DO NOT USE-USE 1156561</p> 
<p>HEAD END LEG ASSEMBLY WITH LEG AND LINK ATTACHED</p>	<p>1156563</p> 
<p>LEG STOP BRACKET ANGLED *RIVETED TO CS9 FRAME TO STOP LEG, 4 PER BED</p>	<p>1158788</p> 
<p>KNEE LIFT LINK</p>	<p>1153762</p> 
<p>MATTRESS KEEPER *2 PER BED, CAN MAKE BED EITHER 76" OR 80"</p>	<p>Standard 36" 1152549 39" wide 1159606 42" wide 1159576</p> 
<p>80" WIREFORM *12.44"</p>	<p>1152550</p> 



Yes, you can.

CS5 Service Parts Replacement Guide

80" WIREFORM TRAPEZE *14.44"	1152551 
CASTERS	
RIGHT SIDE CASTER ASSEMBLY	1147533 
LEFT SIDE CASTER ASSEMBLY	1156581 
3" CASTER LOCKING	1147527 
3" CASTER NON LOCKING	1147526 
WASHER FOR BETWEEN CASTER AND BRACKET	1152559 



Yes, you can:

CS5 Service Parts Replacement Guide

	
ACORN NUT FOR CASTERS	1147523 
5/16" HEX HEAD CAP SCREW	BLT5163—Part is NON SALEABLE 
STEEL WASHER	WSR516—Part is NON SALEABLE 
BRACKET CASTER DUAL BUSHING	1147514 
PLASTIC WASHER	1152558--—Part is NON SALEABLE 
LOWER LEG WEDGE BUSHING	1143736--—Part is NON SALEABLE 
BRACKET CASTER DUAL TRIM	1147513--—Part is NON SALEABLE



Yes, you can.

CS5 Service Parts Replacement Guide

	
5/16" FLANGED NUT	NUT516FL—New part 1186907 
HEAD/FOOT BOARD PARTS	
<p>BED END BRACKET FOOT RIGHT/ HEAD LEFT PLATED *BEDS BUILT PRIOR TO SEPT. 5/08</p> <p>*BEDS BUILT AS OF SEPT. 5/08 -----></p>	<p>1149696NLA Order 1158469 (Headboard Kit) ****Only if replacing on head end of bed. If replacing on foot end order new set of boards, and 1159596 x2</p> <p>1159591---Part is NON SALEABLE</p> 
<p>BED END BRACKET FOOT LEFT/ HEAD RIGHT PLATED *BEDS BUILT PRIOR TO SEPT. 5/08 *BEDS BUILT AS OF SEPT. 5/08</p>	<p>1149697NLA Order 1158469 (Headboard Kit) 1159590 ---Part is NON SALEABLE</p> 
HD/FT BOARD LOCKING KEY	1156522 



Yes, you can.

CS5 Service Parts Replacement Guide

<p>FOOTBOARD POST BRACKET *FOR BEDS BUILT AS OF SEPT. 5/08</p>	<p>1156557 </p>
<p>FOOTBOARD POST BRACKET *BEDS BUILT PRIOR TO SEPT. 5/08</p>	<p>1151757 NLA Order a new set of boards, and 1159596 x 2 </p>
<p>HEADBOARD POST *FOR BEDS BUILT AS OF SEPT. 5/08</p>	<p>1156564 </p>
<p>RIGHT HEADBOARD POST *BEDS BUILT PRIOR TO SEPT. 5/08</p>	<p>1149744 NLA Order 1158469 Headboard KitA </p>
<p>LEFT HEADBOARD POST *BEDS BUILT PRIOR TO SEPT. 5/08</p>	<p>1149745 NLA Order 1158469 Headboard KitA </p>
<p>FOOT BOARD LOCK LATCH LEFT *BEDS BUILT PRIOR TO SEPT 5/08</p>	<p>1153400 NLA Order a new set of boards, and 1159596 x 2 </p>
<p>FOOT BOARD LOCK LATCH RIGHT *BEDS BUILT PRIOR TO SEPT. 5/08</p>	<p>1153399 NLA Order a new set of boards, and 1159596 x 2 </p>
<p>HEAD BOARD LOCKING LATCH *BEDS BUILT PRIOR TO SEPT. 5/08</p>	<p>1149748 NLA 1158469 Headboard KitA </p>
<p>HEAD/FOOT BOARD MOUNTING HARDWARE KIT *INCLUDES POSTS, NUTS & BOLTS Doesn't include brackets</p>	<p>*BEDS BUILT PRIOR TO SEPT. 5/08 KIT79 NLA Order a New set of boards, 1158469, and 1159596 x2 *BEDS BUILT AS OF SEPT. 5/08 1159650</p>

LEG AND LINK ASSEMBLY PARTS



Yes, you can:

CS5 Service Parts Replacement Guide

LEG & LINK ASSEMBLY	1147534 
BED LEG	1149705 DO NOT USE USE 1147534— Part is obsolete 
STABILIZER LINK	1149704--—Part is NON SALEABLE 
NYLON WASHER	1147541 
CAM BUSHING STEEL	1145036--—Part is NON SALEABLE 
PLAIN WASHER	1147612--—Part is NON SALEABLE 
PUSH NUT	1147519 
BUSHING GLIDE WHITE	1144984 



Yes, you can:

CS5 Service Parts Replacement Guide

PINS, NUTS, BOLTS, SPACERS

MOTOR MOUNT CLEVIS PIN 3/8 X 2"	PIN3802—New part 1186864 
BOWTIE COTTER PIN 3/8"	PINBOW38---Part is NON SALEABLE 
DECK TO FRAME CLEVIS PIN	1147565 
PUSH NUT FOR FRAME CLEVIS AND KNEE RATCHET CLEVIS PINS	NUT516PN—Part is Obsolete 
LEG – LINK CLEVIS PIN	1147524 
PUSH NUT .375	1147566 
KNEE RATCHET CLEVIS PIN	PIN51634---Part is NON SALEABLE 



Yes, you can:

CS5 Service Parts Replacement Guide









<p>KNEE RATCHET WASHER</p>	<p>WSR3834116N --Part is Obsolete</p> 
<p>BOLT TO ATTACH HD/FT BOARD BRACKET TO FRAME</p>	<p>BLT1434—New part 1186877</p> 
<p>LOCK NUT FOR ABOVE BOLT PURPLE INSERT</p>	<p>NUT14L—New part 1186860</p> 
<p>PLASTIC SPACER FOR FOOT MOTOR EXTENSION TUBE</p>	<p>WSR3834516N—New part 1186872</p> 
<p>MOTOR CABLE HOLDER</p>	<p>WIRECLIP</p> 

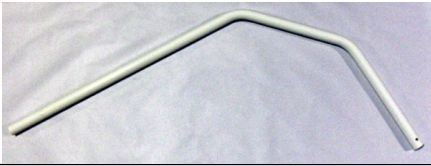

Yes, you can.

CS5 Service Parts Replacement Guide

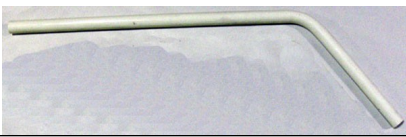



ADDITIONAL OPTIONS

<p>STANDARD TRAPEZE ADAPTER KIT, COMES WITH TRAPEZE BAR *ALSO COMES WITH TRAPEZE WIREFORM (NOT SHOWN)</p>	<p>IHCSTRP</p> 
<p>STANDARD TRAPEZE HARDWARE KIT</p>	<p>1153381</p> 
<p>STANDARD TRAPEZE BAR ONLY</p>	<p>1153383—Part is OBSOLETE</p> 
<p>HEAVY DUTY TRAPEZE ADAPTER KIT, COMES WITH TRAPEZE BAR *ALSO COMES WITH TRAPEZE WIREFORM (NOT SHOWN)</p>	<p>IHCSTRPHD</p> 
<p>HEAVY DUTY TRAPEZE HARDWARE KIT</p>	<p>1153382</p> 
<p>HEAVY DUTY TRAPEZE BAR ASSEMBLY *COMES WITH 2 BARS AND 1 BOOM</p>	<p>1156578—Part is Non saleable</p> 
<p>HEAVY DUTY TRAPEZE BAR ONLY</p>	<p>1147211—Part is Non saleable</p> 
<p>HEAVY DUTY TRAPEZE BOOM ONLY</p>	<p>1153384—Part is Non saleable</p> 

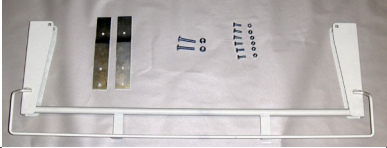
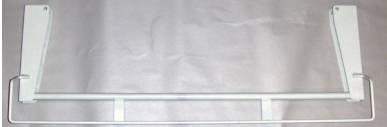
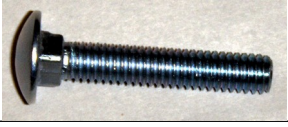

Yes, you can.

CS5 Service Parts Replacement Guide

<p>TRAPEZE MOUNTING BRACKET RIGHT SIDE LEFT SIDE *ORDER BOTH PART NUMBERS TO GET THE PART SHOWN, ONLY ORDERED AS A SET</p>	<p>1147610—Part is Non saleable 1147611—Part is Non saleable</p> 
<p>TRAPEZE BAR HANDLE</p>	<p>1147563</p> 
<p>4" EXTENSION KIT</p>	<p>1153769</p> 
<p>MATTRESS EXTENSION ONLY</p>	<p>1149711</p> 
<p>MATTRESS EXTENSION BOLT</p>	<p>BLT516134C—Part is Obsolete</p> 
<p>MATTRESS EXTENSION NUT</p>	<p>NUT516NL—Part is Non saleable</p> 
<p>EXTENDER BED END BRACKET ONLY</p>	<p>1153401—Part is Non saleable</p> 
<p>BED END BRACKET BOLT</p>	<p>BLT1434—Part is Obsolete</p> 
<p>BED END BRACKET NUT</p>	<p>NUT14L--1186860</p> 



Yes, you can.

CS5 Service Parts Replacement Guide

<p>OLD LOCKOUT BOX (WHITE)</p> <p>NEW LOCKOUT BOX (BLACK)</p>	<p>1147270NLA Old White Box use 1157344 1157344 New Box with Bracket</p> 
<p>BED END BRACKET FOOT RIGHT W/LOCKOUT BOX BRACKET</p> <p>NEW END BRACKET FOR NEW BLACK LOCKOUT BOX</p>	<p>1142186—Part is Non saleable</p>  <p>1158798</p>
<p>LOCKOUT BOX EXTENSION CABLE *ALSO ORDER 1161877</p>	<p>1151724</p> 
<p>T-CABLE 1346MM USED ON BEDS WITH LOCKOUT BOXES</p>	<p>1147271</p> 
<p>HEAD MOTOR CPR RELEASE OPTION *NUMBER ON MOTOR IS 1147571 *INCLUDES 3 WIRETIES</p>	<p>1159614 --Part is Obsolete</p> 
<p>BED END BRACKET FOOT LEFT FOR CPR RELEASE BEDS</p>	<p>1149710--Part is Obsolete</p> 
<p>CPR RELEASE HANDLE WITH CABLE</p>	<p>1147241</p> 
<p>BATTERY CABLE PORT</p>	<p>1175550</p> 
<p>SCREW FOR CPR RELEASE</p>	<p>1147239--Part is Obsolete</p> 

CS5 Service Parts Replacement Guide

RAILS

***LEFT AND RIGHT IS DETERMINED BY LYING IN THE BED**

<p>SET OF ASSIST RAILS NO GUARD</p>	<p>IHCSRLAS-QSP IHCSRLAS-NG</p> 
<p>LEFT ASSIST RAIL ONLY</p>	<p>1152575NLA must order set</p> 
<p>RIGHT ASSIST RAIL ONLY</p>	<p>1152574NLA must order set</p> 
<p>SET OF ASSIST BARS</p>	<p>IHCSBAAS-QSP</p> 
<p>LEFT ASSIST BAR ONLY</p>	<p>1152577NLA must order set</p> 
<p>RIGHT ASSIST BAR ONLY</p>	<p>1152576NLA must order set</p> 
<p>ASSIST RAIL MOUNTING HARDWARE KIT 1153764</p>	<p>ASSIST BAR MOUNTING HARDWARE KIT 1159610</p>



Yes, you can:



CS5 Service Parts Replacement Guide

	
<p>LEFT RAIL BRACKET ONLY 1149723NLA must order set of rails</p>	<p>RIGHT RAIL BRACKET ONLY 1149722NLA must order set of rails</p>
	
<p>SET TS HEAD POSITIONING RAILS *FOR BEDS BUILT PRIOR TO FEB 5/09 YOU MUST ALSO ORDER 1158933</p>	<p>IHCSTSPD-QSP</p> 
<p>LEFT TS HEAD POSITIONING RAIL</p>	<p>1161868NLA must order set</p> 
<p>RIGHT TS HEAD POSITIONING RAIL</p>	<p>1161867NLA must order set</p> 
<p>TS HEAD POSITIONING RAIL HARDWARE KIT</p>	<p>1161869 Retaining Pins Only 1165069</p> 
<p>68" PARTIAL RAIL SET</p>	<p>IHC SRLPA</p>

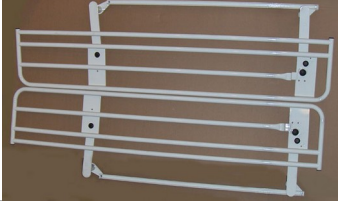

Yes, you can.

CS5 Service Parts Replacement Guide

	
68" LEFT PARTIAL RAIL	1153600NLA 
68" RIGHT PARTIAL RAIL	1153601NLA 
PARTIAL RAIL LINKAGE BAR	1153595—Part is Non saleable 
FOOT END LEFT RAIL ARM 1153588—Part is Non saleable 	FOOT END RIGHT RAIL ARM 1153589—Part is Non saleable 
HEAD END LEFT RAIL ARM 1153590—Part is Non saleable 	HEAD END RIGHT RAIL ARM 1153591—Part is Non saleable 
RAIL MOUNTING BRACKET LEFT 1157319—Part is Obsolete	RAIL MOUNTING BRACKET RIGHT 1157318— Part is Obsolete 
RAIL MOUNTING KIT 1153610 	RAIL HARDWARE KIT 1153768 



Yes, you can.

CS5 Service Parts Replacement Guide

PULL KNOB ASSEMBLY FOR ALL RAILS

Assist Rail Springs- Kit of 10
1165067



BALL KNOB KIT
KIT26—New part 1189259

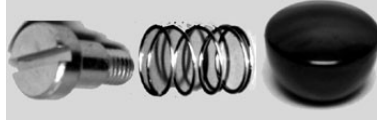

MEMBRANES

151 PAD CS3/5 (No Contour)
1156571



MEMBRANE STRAIGHT CABLE
1151724



INBOARD MALE CABLE – J1
1151720



INBOARD FEMALE CABLE – J2
1151721

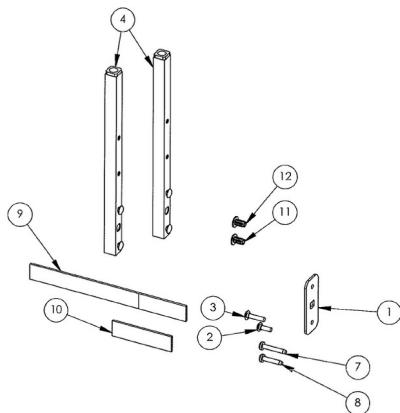
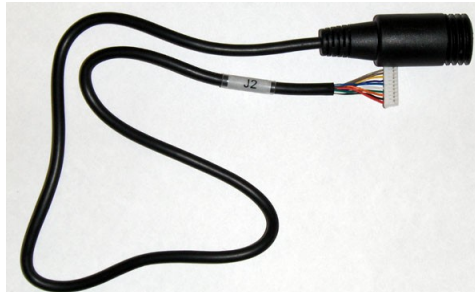

Head/Foot Board Mounting Hardware Kit
1159650



CS5 Service Parts Replacement Guide

Old Style Latch HeadBoards to be replaced with:

Headboard Kit A

1156564 (x2)

1159590 (x1)—Part is non saleable

1159591 (x1))—Part is non saleable

1158404 Replacement Instructions (x1)

Old Style Latch Footboards to be replaced with:

Footboard Kit B

1159590 (x2))—Part is non saleable

1159591 (x2))—Part is non saleable

1158404 Replacement Instructions (x1)

Headboard Pattern & Footboard Pattern

CS Pan Deck Kit 1153380